

# Hand lever valve (5/2 way, 5/3 way)

## 4H Series



### Specification

Model	210-06	230-06	210-08	230-08	310-08	330-08	310-10	330-10
Fluid	Air (to be filtered by 40 μm filter element)							
Operating	Manual control direct acting type							
Port size <sup>①</sup>	In=Out=Exhaust=1/8"		In=Out=1/4" Exhaust=1/8"		In=Out =Exhaust=1/4"		In=Out=3/8" Exhaust=1/4"	
Orifice size	14.0mm <sup>2</sup> (Cv=0.78)	12.0mm <sup>2</sup> (Cv=0.67)	16.0mm <sup>2</sup> (Cv=0.89)	12.0mm <sup>2</sup> (Cv=0.67)	25.0mm <sup>2</sup> (Cv=1.39)	18.0mm <sup>2</sup> (Cv=1.00)	30.0mm <sup>2</sup> (Cv=1.67)	18.0mm <sup>2</sup> (Cv=1.00)
Valve type	5/2 Way	5/3 Way	5/2 Way	5/3 Way	5/2 Way	5/3 Way	5/2 Way	5/3 Way
Lubrication <sup>②</sup>	Not required							
Pressure range	0~0.8MPa(0~116psi)							
Proof pressure	1.5MPa(215psi)							
Temperature	-20~70°C							
Material body	Aluminum alloy							
Operating angle	±15°	±8.5°	±15°	±8.5°	±18°	±10°	±18°	±10°

① PT thread, NPT thread and G thread are available;

② Once lubricated air is used, continue with same medium to optimise valve life span. It is suggested to use ISO VG32 lubricant or the oil with the same grade.

### Symbol

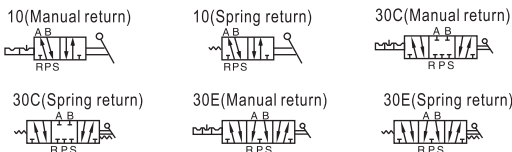

### Product feature

1. Manual operation, smooth actuation, and exact and reliable orientation.
2. Sliding column structure has good tightness and light weight and is easy to install and dismount.
3. Internal hole adopts special processing technology which has little attrition friction, long service life.
4. No need to add oil for lubrication.
5. Panel-mounting makes it convenient to install and apply.

### Flow chart

Model: 4H210-08

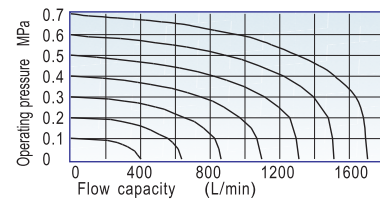

Model: 4H310-10

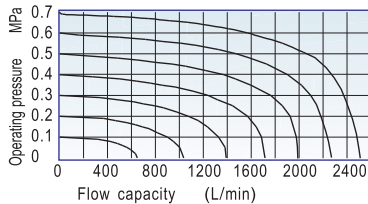

### Installation

1. 5/3 way manual return hand lever valve is positioned by steel ball, which is convenient to switch. Please apply the proper force to avoid the position mismatch and misoperation.
2. When installed by panel, disassemble the gasket according to the practical requirement.
3. Below is the installation method for reference.

Note: Please give your attention on the panel thickness and hole dimension when installed by panel.

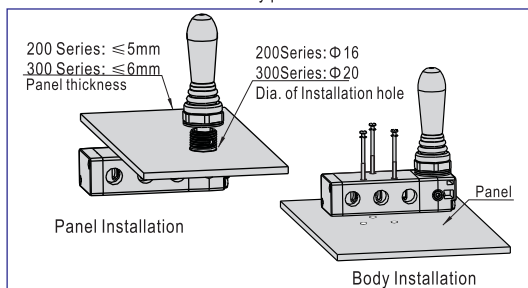

### Ordering code

**4H 2 30C 08** □

- Model**
  - 4H: Manual return
  - 4HA: Spring return
- Code**
  - 2: 200 Series
  - 3: 300 Series
- Valve type**
  - 10: 5/2 Way
  - 30C: 5/3 Way closed center
  - 30E: 5/3 Way exhaust center
- Thread type**
  - Blank: PT
  - T: NPT
  - G: G
- Port size**

Code	Port size
200 Series	06: 1/8"
	08: 1/4"
300 Series	08: 1/4"
	10: 3/8"

### Inner structure

**4H210**

**4HA230C**

No.	Item
1	Round head screw
2	Bottom cover
3	Body
4	O-ring
5	Spool
6	Top cover
7	Round head cover
8	Axle
9	Stop screw
10	Spring
11	Steel ball jacket
12	Steel ball
13	E clip
14	Side cover
15	Spring
16	Spring holder

### ■ Dimensions

#### 4H210\310, 4HA210\310

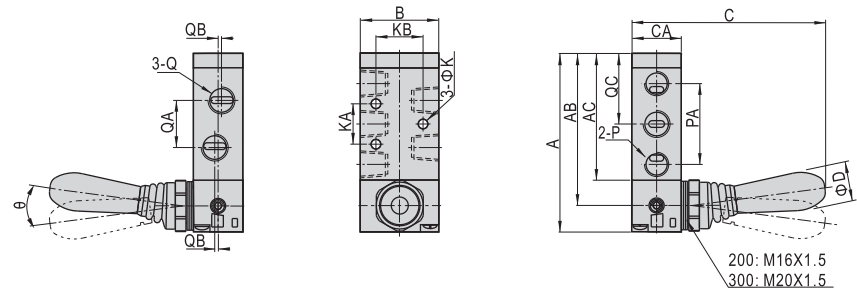

Model\Item	A	AB	AC	B	C	CA	D	K	KA	KB	P	PA	Q	QA	QB	QC	Ø
4H210-06 4HA210-06	81.5	69.5	57.5	35	90	22	18	4.3	20	23.5	1/8"	36	1/8"	18	-	32.5	15
4H210-08 4HA210-08	81.5	69.5	57.5	35	90	22	18	4.3	20	23.5	1/8"	36	1/4"	21	1.5	32.5	15
4H310-08 4HA310-08	101	87	73	40	93.5	27	18	4.3	24	27.5	1/4"	45	1/4"	22	-	40.5	18
4H310-10 4HA310-10	101	87	73	40	93.5	27	18	4.3	24	27.5	1/4"	45	3/8"	24	2	40.5	18

#### 4H230C\330C, 4H230E\330E

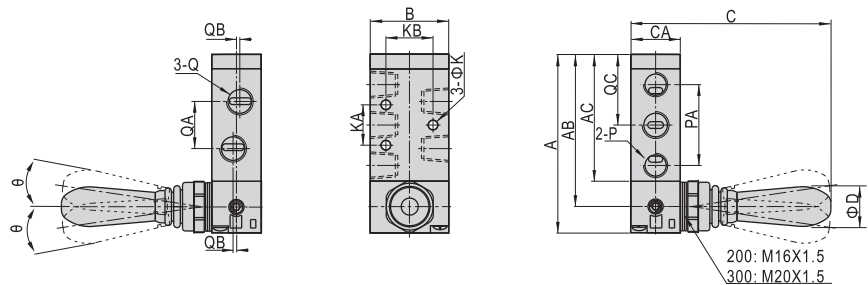

Model\Item	A	AB	AC	B	C	CA	D	K	KA	KB	P	PA	Q	QA	QB	QC	Ø
4H230C-06 4H230E-06	81.5	69.5	57.5	35	90.5	22	18	4.3	20	23.5	1/8"	36	1/8"	18	-	32.5	8.5
4H230C-08 4H230E-08	81.5	69.5	57.5	35	90.5	22	18	4.3	20	23.5	1/8"	36	1/4"	21	1.5	32.5	8.5
4H330C-08 4H330E-08	101	87	73	40	94	27	18	4.3	24	27.5	1/4"	45	1/4"	22	-	40.5	10
4H330C-10 4H330E-10	101	87	73	40	94	27	18	4.3	24	27.5	1/4"	45	3/8"	24	2	40.5	10

#### 4HA230C\330C, 4HA230E\330E

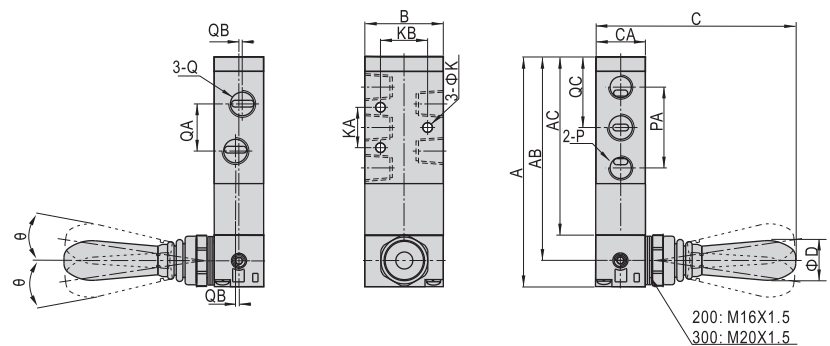

Model\Item	A	AB	AC	B	C	CA	D	K	KA	KB	P	PA	Q	QA	QB	QC	Ø
4HA230C-06 4HA230E-06	100.5	88.5	76.5	35	90.5	22	18	4.3	20	23.5	1/8"	36	1/8"	18	-	32.5	8.5
4HA230C-08 4HA230E-08	100.5	88.5	76.5	35	90.5	22	18	4.3	20	23.5	1/8"	36	1/4"	21	1.5	32.5	8.5
4HA330C-08 4HA330E-08	120	106	92	40	94	27	18	4.3	24	27.5	1/4"	45	1/4"	22	-	40.5	10
4HA330C-10 4HA330E-10	120	106	92	40	94	27	18	4.3	24	27.5	1/4"	45	3/8"	24	2	40.5	10

